

# We are IntechOpen, the world's leading publisher of Open Access books Built by scientists, for scientists

4,000

Open access books available

116,000

International authors and editors

120M

Downloads

Our authors are among the

154

Countries delivered to

TOP 1%

most cited scientists

12.2%

Contributors from top 500 universities



WEB OF SCIENCE™

Selection of our books indexed in the Book Citation Index  
in Web of Science™ Core Collection (BKCI)

Interested in publishing with us?  
Contact [book.department@intechopen.com](mailto:book.department@intechopen.com)

Numbers displayed above are based on latest data collected.  
For more information visit [www.intechopen.com](http://www.intechopen.com)



---

# Kinetic Methods of Analysis with Potentiometric and Spectrophotometric Detectors – Our Laboratory Experiences

---

Njegomir Radić and Lea Kukoc-Modun

Additional information is available at the end of the chapter

<http://dx.doi.org/10.5772/52185>

---

## 1. Introduction

The basic types of reactions used for determinative purpose encompass the traditional four in equilibrium-based measurements: precipitation (ion exchange), acid-base (proton exchange), redox (electron exchange) and complexation (ligand exchange). These four basic types, or cases that can be reduced to them, are also found in kinetic-based measurements with some distinguishable trends. The influence of concentration on the position of a chemical equilibrium is described in quantitative terms by means of an equilibrium-constant expression. Such expressions are important because they permit the chemist to predict the direction and completeness of a chemical reaction. However, the size of one equilibrium constant tells us nothing about the rate (the kinetic) of the reaction. A large equilibrium constant does not imply that a reaction is fast. In fact, we sometimes encounter reactions that have highly favorable equilibrium constants but are of slight analytical use because their rates are low. Commonly used kinetic methods based on chemistry of reaction employed have been selected [1, 2].

Kinetic methods of analysis are based on the fact that for most reactions the rate of the reaction and the analytical signal increase with an increase of the analyte concentration. In kinetic methods, measurement of the analytical signal is made under dynamic conditions in which the concentrations of reactants and products are changing as a function of time.

Generally, in analytical chemistry many methods of analysis are based on the equilibrium state of the selected reaction. In contrast to kinetic methods, equilibrium or thermodynamic methods are performed on systems that have come to equilibrium or steady state, so that the analytical signal should be stable during measurements. Kinetic and equilibrium parts of the selected chemical reaction are illustrated in the figure 1.

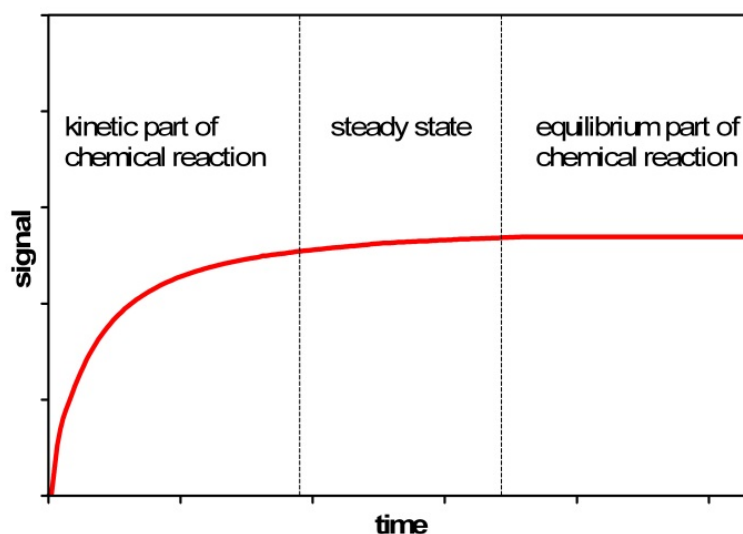

**Figure 1.** Kinetic, steady state and equilibrium parts of the selected chemical reaction

The most important advantage of kinetic method of the analysis is the ability to use chemical reaction that is slow to reach equilibrium. By using kinetic methods determination of a single species in a mixture may be possible when species have sufficient differences of reaction rates. In this chapter we present two analytical techniques where experimental measurements are made while analytical system is under kinetic control: i) chemical kinetic techniques, ii) flow injection analysis. The use of potentiometric and spectrophotometric detectors in kinetic methods are discussed. Also, the preparation and potential response of solid state potentiometric chemical sensors are described.

## 2. Kinetic methods of analysis with potentiometric detector

A potentiometric chemical sensor or ion-selective electrode conforms to the Nernst equation (1)

$$E = E^0 + k \log a_i \quad (1)$$

where  $E$  = the measured cell potential,  $E^0$  = a constant for a given temperature,  $a_i$  = activity of an analyte ion in an aqueous solution and  $k = RT \log(10)/nF$  where  $R$  is the gas constant,  $T$  is the absolute temperature,  $F$  is Faraday's constant and  $n$  is the number of electrons discharged or taken up by one ion (molecule) of an analyte. Usually, but not necessarily,  $n$  equals the charge (with sign) on the ionic form of the analyte. In practice, for constructing a calibration graph, it is normal to use solution concentrations instead of activities since concentration is more meaningful term to the analytical chemist than the activity. There are several points which should be noted from the response behaviors of the potentiometric chemical sensors when calibration graphs are constructed [3].

The electrode potential developed by an ion-selective electrode in a standardizing solution can vary by several millivolts per day for different measurements. For accurate

measurement, therefore, the electrodes should be restandardized several times during the day. For a single determination, an error of 0.1 mV in measurements of the electrode potential results in an error of 0.39% in the value of monovalent anion activity [4]. Direct potentiometric measurements are usually time-consuming experiments.

Kinetic potentiometric methods are powerful tool for analysis, since they permit sensitive and selective determination of many samples within a few minutes with no sample pretreatment in many cases. The application of kinetic potentiometric methods offers some specific advantages over classical potentiometry, such as improved selectivity due to measurements of the evolution of the analytical signal with the reaction time. To construct calibration graphs the initial rate of the complex (product) formation reaction or change in potential during fixed time interval are used.

### 2.1. Use of potentiometric chemical sensors in aqueous solution

The fluoride ion-selective electrode (FISE) with  $\text{LaF}_3$  membrane has proved to be one of the most successful ion-selective electrodes. FISE has a great ability to indirectly determine whole series of cations which form strong complexes with fluoride (such as  $\text{Al}^{3+}$ ,  $\text{Fe}^{3+}$ ,  $\text{Ce}^{4+}$ ,  $\text{Li}^+$ ,  $\text{Th}^{4+}$ , etc.). Combination of the simplicity of the kinetic method with the advantages of this sensor (low detection limit, high selectivity) produces an excellent analytical technique for determination of metal ions that form complexes with fluoride. Suitability of the FISE for monitoring a reasonable fast reaction of the formation of  $\text{FeF}^{2+}$  in acidic solution has been established by Srinivasan and Rechnitz [5]. Determination of Fe(III), based on monitoring of the formation of  $\text{FeF}^{2+}$  using FISE is described [6]. In this work, the kinetics of the  $\text{FeF}^{2+}$  formation reaction were studied in acidic solution (pH = 1.8; 2.5). The initial rates of iron(III)-fluoride complex formation in the solution, calculated from the non-steady-state potential values recorded after addition of Fe(III), were shown to be proportional to the analytical concentration of this ion in cell solution. The initial rate of the complex formation reaction, or change in potential during fixed time interval (1 minute), was used to construct calibration graphs. Good linearity ( $r = 0.9979$ ) was achieved in the range of iron concentration from  $3.5 \times 10^{-5}$  to  $1.4 \times 10^{-5}$  mol  $\text{L}^{-1}$ . The described procedure can be usefully applied for the determination of free Fe(III) or labile Fe(III), as the fluoride may displace weaker ligands.

The determination of aluminium using FISE has mostly been performed in solutions buffered with acetate at pH 5, where fluorine is in the  $\text{F}^-$  form [7, 8]. Potential - time curves recorded during the Al-F complex formation reaction, using potentiometric cell with FISE, constitute the primary data in this study [7]. The initial rates decrease of the concentration of free fluoride ion were calculated and shown to be proportional to the amount of aluminium in reaction solution. The described method, based on the experimental observations, provides the determination of aluminium in the range from 8 to 300 nmol.

Aluminium(III) ions in aqueous solution show marked tendency to hydrolyse, with the formation of soluble, polynuclear hydroxo and aquo complexes and a precipitate of

aluminium(III) hydroxide. The kinetic of the  $\text{AlF}_i^{(3-i)+}$  formation reactions were also studied in acidic solution (pH 2) where both HF and  $\text{HF}_2^-$  exist, but parallel reactions of aluminium are avoided. The initial rates of aluminium-fluoride complex formation in this acidic solution, calculated from the non-steady-state potential values recorded after addition of aluminium, were shown to be proportional to the amount of this ion added [9].

The kinetic of aluminium fluoride complexation was studied in the large pH range. In the range of 0.9 – 1.5 [5], and from 2.9 to 4.9 [10].

Due to the toxicity of monomeric aluminium in free (aquo) and hydroxide forms, its rate of complexation with fluoride in the acidified aquatic environment is very important. A kinetic investigation of the rate and mechanism of reaction between Al(III) ions and fluoride in buffered aqueous solution (pH values 2 and 5) was described. The important paths of complex forming and the ecological importance of aluminium fluoride complexation in acidified aquatic environments were discussed [11]. In the laboratory solution, or in the aquatic environment, contains aluminium and fluoride ions, the following reactions may be considered to be the important path for aluminium-fluoride formation:

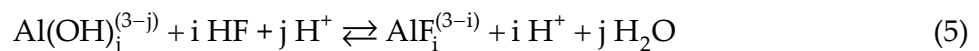
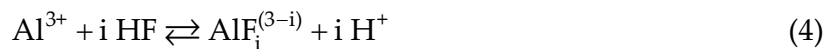
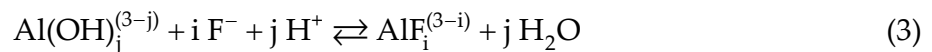

in these reactions, coordinated water has been omitted for simplicity. Under the experimental conditions where  $c_{\text{Al}} \gg c_{\text{F}}$ , the formation of  $\text{AlF}_2^+$  complex may be expected through one of the four possible paths (Eqs. 2–5), depending on the solution acidity. According to the theoretical consideration, after addition of aluminium, the recorded change in potential of the cell with FISE was higher at pH 2 than at pH 5. However, the rate of aluminium fluoride complexation is slightly slower at pH 2 than at pH 5.

Kinetic method of potentiometric determination of Fe(III) with a copper(II) selective electrode based on a metal displacement reaction is described [12]. Addition of various amounts of iron(III) to the buffered (pH 4) Cu(II)-EDTA cell solution alters the concentration of free copper(II) ion in the solution. EDTA is well known abbreviation for *ethylenediaminetetraacetic acid*, a compound that forms strong 1:1 complexes with most metal ions. EDTA is a hexaprotic system, designated  $\text{H}_6\text{Y}^{2+}$ . When iron(III) is added to a buffered aqueous solution containing  $\text{CuY}^{2-}$  species same cupric ion will be displaced because  $K_{\text{FeY}^-} > K_{\text{CuY}^{2-}}$ :

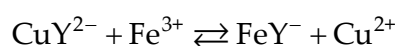

The above ligand exchange between two metals is often sluggish because the reaction involves breaking a series of coordinate bonds in succession [2]. As already noted [7], the rate of change in the potential, expressed as  $dE/dt$ , is directly proportional to the rate of change of the concentration of the potential determining ion,  $\text{Cu}^{2+}$  in this experiment, with time. The calculated values,  $\Delta E/\Delta t$  versus  $\log c_{\text{Fe(III)}}$  was found to be linear for different concentrations of the Cu-EDTA complex, which was used as “kinetic substrate”. The linear or analytical range for each tested concentrations of Cu-EDTA was close to one decade of iron concentration.

Kinetic potentiometric method for the determination of thiols (RSH): L-cysteine (cys), N-acetyl-L-cysteine (NAC), L-glutathione (glu) and D-penicillamine (pen) has been presented [13]. The proposed method is based on the reaction of formation the sparingly soluble salts,  $\text{RSAg}$ , between RSH and  $\text{Ag}^+$ . During the kinetic part of this reaction potential-time curves were recorded by using commercial iodide ion selective electrode with AgI-based sensitive membrane *versus* double-junction reference electrode as one potentiometric detector. The change of cell potential was continuously recorded at 3.0-sec interval. When the potential change,  $\Delta E$ , recorded in 5<sup>th</sup> min. after RSH had been added in reaction solution, were plotted *versus* the negative logarithm of RSH concentration,  $p(\text{RSH})$ , rectilinear calibration graphs were obtained in the concentration ranges from  $1.0 \times 10^{-5}$  to  $1.0 \times 10^{-5}$  mol  $\text{L}^{-1}$ . The applicability of the proposed method was demonstrated by determination of chosen compounds in pharmaceutical dosage forms.

## 2.2. Use of potentiometric chemical sensors in non-aqueous solution

A change in solvent may cause changes in thermodynamic as well as kinetic properties of the selected chemical reaction. Also, the solubility of sensing membrane of one potentiometric chemical sensor, stability of the forming complexes, adsorption of reactants on the membrane and any undefined surface reaction may be strongly solvent dependent. Furthermore, the main properties of the used sensor which are important for analytical application such as sensitivity, selectivity response time and life-time, may be altered in non-aqueous solvents. In our experiments we have investigated different aqueous + organic solvent mixtures and their influence on thermodynamic and kinetic of the chemical reaction employed. Baumann and Wallace showed that cupric-selective electrode and a small amount of the copper(II)-EDTA complex could be used for the end-point detection in chelometric titrations of metals for which no electrode was available [14]. In the case of the compleximetric titration of mixtures of copper(II) an other metal ion in aqueous solution only the sum of both metals can be determined [15]. Titration measurements in the ethanol-aqueous media by using cupric ion-selective electrode as the titration sensor showed the possibility of direct determination of copper(II) in the presence of different quantity of iron(III) [16].

Sulfide ion-selective electrode was used as potentiometric sensor for determination of lead(II) in aqueous and nonaqueous medium. The initial rate of  $\text{PbS}$  formation was studied for series of solutions at various concentration of sodium sulfide and different pH values.

The measurements of lead sulfide formation in the presence of ethanol in 50% V/V were carried out in order to study the effect of organic solvent on the formation of the lead sulfide precipitate. After addition of Pb(II) ion, in water-ethanol mixtures, ethanol yielded higher potential jumps than in aqueous media [17].

Generally titrations in aqueous and nonaqueous media offer numerous advantages over direct potentiometry [18]. As it was mentioned, a change in solvent may cause changes in thermodynamic as well as in kinetic properties of the ions present. Also, the solubility of the FISE membrane, the stability of other metal fluorides, adsorption of fluoride ion and/or metal ions on the membrane and any undefined surface reaction, may be strongly solvent dependent. Furthermore, the main properties of the electrode used such as sensitivity, selectivity, response time and life time may be altered in non-aqueous solvents. Many papers have been concerned with the behavior of the FISE in a variety of organic solvents and their mixtures with water. Potentiometric titration of aluminium with fluoride in organic solvent + water mixtures by using electrochemical cell with FISE has been performed [19]. The potential break at the titration curve is not evident when titration is performed in aqueous solution. When the complexometric titration is performed in non-aqueous solution well defined S-shaped titration curves are obtained which suggest a simple stoichiometry of the titration reaction. In nonaqueous solutions, the formation of the complex with the maximum number of ligands (six) is presumably preferred. On the basis of potentiometric titration experiments the overall conditional formation constant of  $\text{AlF}_i^{(3-i)}$  complexes have been calculated. Among the solvents tested (namely: ethanol, *p*-dioxane, methanol, *n*-propanol and tert-butanol) *p*-dioxane yielded a greater potential break than the other solvents and the measurements in mixtures with this solvent and ethanol also showed the best precision. The formation of aluminium hexafluoride complex in organic solvent + water mixtures may be accepted for the titration of higher concentration of aluminium ( $> 10^{-5} \text{ mol L}^{-1}$ ). However, at a low concentration of aluminium, the stoichiometric ratio between aluminium and fluoride was constant for a narrow range of aluminium concentrations and can be determined by experiment only.

The potentiometric determination of aluminium in 2-propanol + water mixtures was described [20]. The theoretical approach for the determination of aluminium using two potentiometric methods (potentiometric titration and analyte subtraction potentiometry) was discussed. The computed theoretical titration curves show that the equivalence point is signaled by great potential break only in media where aluminium forms hexafluoride complex. On the basis of the potentiometric titration and the known subtraction experiments in 2-propanol + water mixtures, the overall conditional constants  $\{\beta'(\text{AlF}_6^{3-})\}$  were calculated. The calculated average  $\beta'$ -values are  $10^{31}$  and  $10^{33}$ , depending on the vol% of organic solvent, 50% and 67%. In the mixtures having a vol% of organic solvent of 50% or 67%, both methods can be applied for the determination of aluminium, *via*  $\text{AlF}_6^{3-}$  complex formation, in the concentration range from  $1.0 \times 10^{-4}$  to  $1.0 \times 10^{-3} \text{ mol L}^{-1}$ .

### 3. Kinetic methods of analysis with spectrophotometric detector

In this chapter kinetic spectrophotometric methods are concerned to determination of thiols and similar compounds in pharmaceutical dosage forms. In fact, the spectrophotometric technique is the most widely used in pharmaceutical analysis, due to its inherent simplicity, economic advantage, and wide availability in most quality control laboratories. Kinetic spectrophotometric methods are becoming a great interest for the pharmaceutical analysis. The application of these methods offers some specific advantages over classical spectrophotometry, such as improved selectivity due to the measurement of the evolution of the absorbance with the reaction time. The literature is still poor regarding to analytical procedures based on kinetic spectrophotometry for the determination of drugs in pharmaceutical formulations. Surprisingly, to the authors' knowledge, there are only few published kinetic spectrophotometric methods for the determination of *N*-acetyl-L-cysteine (NAC) [21-23]. Also, only one of the cited methods for the determination of NAC has used  $\text{Fe}^{3+}$  and 2,4,6-tripyridyl-*s*-triazine (TPTZ) as a reagent solution. The reported method [23] is based on a coupled redox-complexation reaction. In the first (redox) step of the reaction, NAC (RSH compound) reduces  $\text{Fe}^{3+}$  to  $\text{Fe}^{2+}$  (Eq. (6)). In the second step of the reaction, the reduced  $\text{Fe}^{2+}$  is rapidly converted to the highly stable, deep-blue coloured  $\text{Fe}(\text{TPTZ})_2^{2+}$  complex (Eq. (7)) with  $\lambda_{\text{max}}$  at 593 nm:

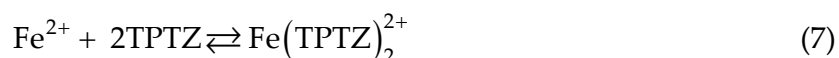
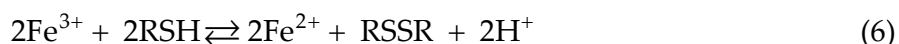

The initial rate and fixed-time (at 5 min) methods were utilized in this experiment. Both methods can be easily applied to the determination of NAC in pure form or in tablets. In addition, the proposed methods are sensitive enough to enable the determination of near nanomole amounts of the NAC without expensive instruments and/or critical analytical reagents. The kinetic manifold for a spectrophotometric determination of NAC or other thiols is shown in Fig. 2.

Kinetic spectrophotometric method for the determination of tiopronin {*N*-(2-mercaptopropionyl)-glycine, MPG} has been developed and validated. This method is also based on the coupled redox-complexation reaction (Eqs. 6, 7.) [24]. The use of TPTZ as chromogenic reagent has improved selectivity, linearity and sensitivity of measurements. The method was successfully applied for determination of MPG in pharmaceutical formulations.

The initial rate and fixed time (at 3 min) methods were utilized for constructing the calibration graphs. The graphs were linear in concentration ranges from  $1.0 \times 10^{-6}$  to  $1.0 \times 10^{-4}$  mol L<sup>-1</sup> for both methods with limits of detection  $1.3 \times 10^{-7}$  mol L<sup>-1</sup> and  $7.5 \times 10^{-8}$  mol L<sup>-1</sup> for the initial rate and fixed time method, respectively. Under the optimum conditions, the absorbance-time curves for the reaction at varying MPG concentrations ( $1.0 \times 10^{-6}$  to  $1.0 \times 10^{-4}$  mol L<sup>-1</sup>) with the fixed concentration of Fe(III) ( $5.0 \times 10^{-4}$  mol L<sup>-1</sup>) and TPTZ ( $5.0 \times 10^{-4}$  mol L<sup>-1</sup>) were generated (Fig. 3).



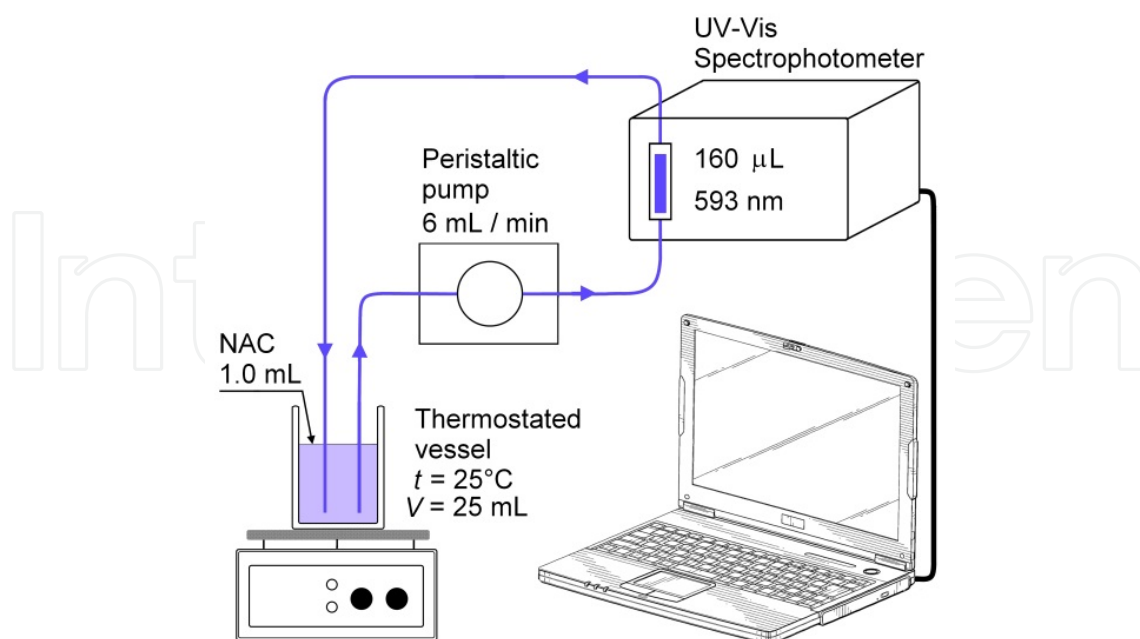

**Figure 2.** Kinetic manifold for the spectrophotometric determination of RSH.  $\lambda = 593 \text{ nm}$  is for  $\text{Fe}(\text{TPTZ})_2^{2+}$  complex.

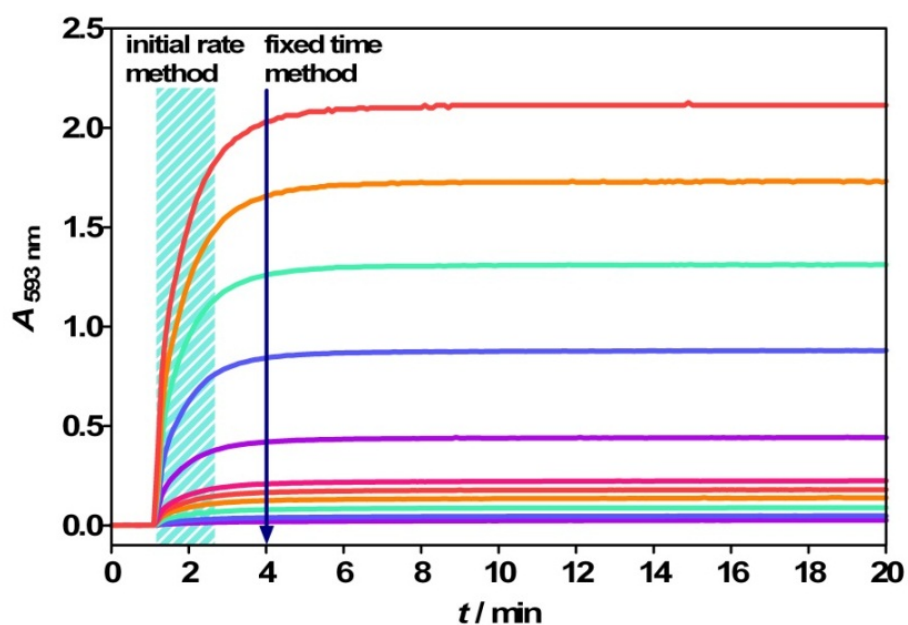
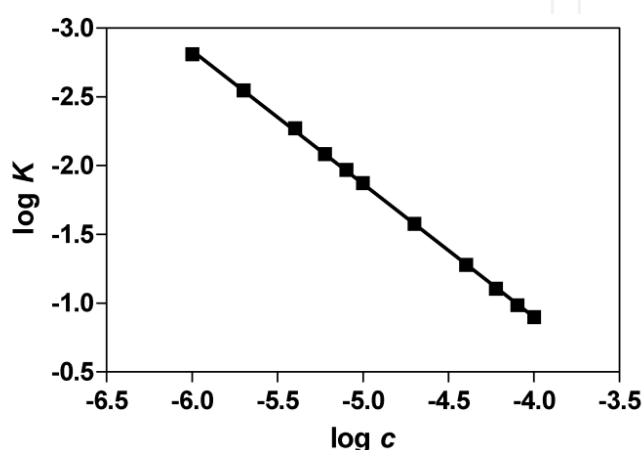

**Figure 3.** Absorbance as the function of time for the coupled redox-complexation reaction, measured at different MPG concentrations ( $1.0 \times 10^{-6}$  to  $1.0 \times 10^{-4} \text{ mol L}^{-1}$ ) - Experimental conditions:  $c(\text{Fe}^{3+}) = 5.0 \times 10^{-4} \text{ mol L}^{-1}$ ,  $c(\text{TPTZ}) = 5.0 \times 10^{-4} \text{ mol L}^{-1}$ ,  $\text{pH} = 3.6$ ,  $t = 25^\circ\text{C}$ , analyte added 1 min after beginning of the measurement.

The initial reaction rates ( $K$ ) were determined from the slopes of these curves. The logarithms of the reaction rates ( $\log K$ ) were plotted as a function of logarithms of MPG concentrations ( $\log c$ ) (Fig.4). The regression analysis for the values was performed by fitting the data to the following equation:

$$\log K = \log k' + n \log c \quad (8)$$

where  $K$  is reaction rate,  $k'$  is the rate constant,  $c$  is the molar concentration of MPG, and  $n$  (slope of the regression line) is the order of the reaction. A straight line with slope values of 0.9686 ( $\approx 1$ ) was obtained confirming the first order reaction. However under the optimized reaction conditions the concentrations of Fe(III) and TPTZ were much higher than concentrations of MPG in the reaction solution. Therefore, the reaction was regarded as a pseudo-first order reaction.

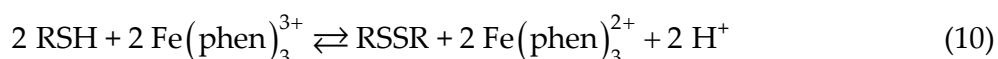
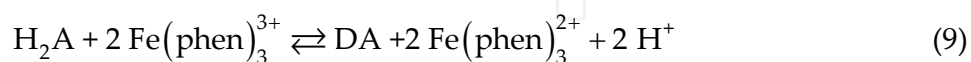

**Figure 4.** Linear plot for  $\log c$  vs.  $\log K$  for the kinetic reaction of MPG with Fe(III) ( $5.0 \times 10^{-4} \text{ mol L}^{-1}$ ) and TPTZ ( $5.0 \times 10^{-4} \text{ mol L}^{-1}$ ).  $c$  is [MPG]: ( $1.0 \times 10^{-6}$  to  $1.0 \times 10^{-4} \text{ mol L}^{-1}$ );  $K$  is the reaction rate ( $\text{s}^{-1}$ ).

A simple kinetic method for the spectrophotometric determination of L-ascorbic acid (AA) and thiols (RSH) in pharmaceutical dosage forms, based on a redox reaction of these compounds with Fe(III) in the presence of 1,10-phenantroline (phen) at pH = 2.8 has been described [21].

Before RSH or AA is added to the reaction solution, Fe(III) and phen have formed a stable complex,  $\text{Fe}(\text{phen})_3^{3+}$ .

The mechanism of redox-reaction of AA or RSH with the formed complex  $\text{Fe}(\text{phen})_3^{3+}$  may be written as:



where  $\text{H}_2\text{A}$  is the reduced form of AA and DA is dehydrogenized AA.

Catalytic-effect Cu(II) proposed by Teshima et al. [25] was applied to enhance analytical signal for slow redox-reaction. The catalytic effect of  $\text{Cu}^{2+}$  on redox-reaction thiols (RSH) with the Fe(III)-phen complex may be written as:

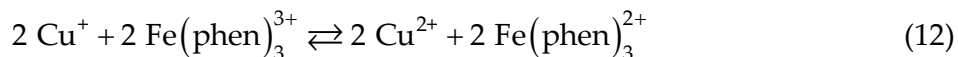
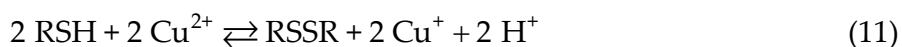

An orange-red iron(II)-phen complex produced by the reaction in Equation (12) absorbs at  $\lambda = 510 \text{ nm}$  and  $\text{Cu}^{2+}$  ions will turn back to the reaction with RSH.

The rates and mechanisms of the chemical reactions, on which all these determinations are based, play a fundamental role in the development of an analytical (spectrophotometric) signal. Therefore, it was greatly important to establish the kinetics of chemical reactions applied for developing the proposed method. This investigation is also important for the optimization of the flow injection method used for the determination of the same compounds.

## 4. Flow injection analysis

In flow-injection analysis (FIA) the sample (analyte) is injected into a continuously flowing carrier stream, where mixing of sample and analyte with reagent(s) in the stream are controlled by the kinetic processes of dispersion and diffusion. Since the concept of FIA was first introduced in 1975 [26], it has had a profound impact on how modern analytical procedures are implemented. FIA with different detector is rapidly developing into a powerful analytical tool with many merits, such as broad scope and rapid sample throughput. The analytical signal monitored by a suitable detection device, is always a result of two *kinetic* processes that occur simultaneously, namely the *physical* process of zone dispersion and the superimposed *chemical* processes resulting from reaction between analyte and reagent species. As a result of growing environmental demands for reduced consumption of sample and reagent solutions, the first generation of FIA, which utilizes continuous pumping of carrier and reagent solutions, was supplemented in 1990 by the second generation, termed sequential injection analysis (SIA). In 2000, the third generation of FIA, the so-called lab-on-valve (LOV) was appeared [27].

### 4.1. FIA-methods with potentiometric detector

Over many years, there has been a great deal of research and development in FIA using ion-selective electrodes as detectors. A different design of flow-through potentiometric sensors has been investigated, but the incorporation of a tubular ion-selective electrode into the conduits of FIA has been used as a nearly ideal configuration, because the hydrodynamic flow conditions can be kept constant throughout the flow system [28].

For the determination of compounds containing sulphur a simple FIA system was developed. A simple tubular solid-state electrode with an AgI-based membrane hydrophobized by PTFE (powdered Teflon) was constructed and incorporated into a flow-injection system. The flow system and the configuration of the constructed tubular flow-through electrode unit have been described [29, 30].

For the experimental measurements, two-channel FIA setup has been used. The tubular electrode and reference electrode are located downstream after mixing two channels. A constant representing a dilution of the sample and/or reagent after mixing of two solutions depends on the flow rates in channels and can be calculated as it has been shown [30].

In this experiment, the iodide electrode with (Ag<sub>2</sub>S+AgI+PTFE)-membrane responds primarily to the activity of the silver ion at the sample solution–electrode membrane interface downstream after a confluence point of two channels. The preparation and performance of a silver iodide-based pellet hydrophobised by PTFE have been described [31].

In FIA experiment, using two-line flow manifold, the potential of the cell with the sensing tubular electrode is given by

$$E_1 = E' + S \log a_{\text{Ag}^+} = E' + S \log (c_{\text{Ag}^+} \cdot m \cdot \alpha_{\text{Ag}^+} \cdot f_{\text{Ag}^+}) \quad (13)$$

where  $S, c, m, \alpha,$  and  $f$  denote the response slope of the electrode, the total or analytical concentration of silver ions in reagent solution, the dilution constant, the fraction of Ag<sup>+</sup>, and the activity coefficient, respectively.

In the absence of ions in the streaming solution that form sparingly soluble silver salts or stable silver complexes and at constant ionic strength, the potential of the sensor can be expressed by the following equation:

$$E_1 = E'' + S \log (c_{\text{Ag}^+} \cdot m) \quad (14)$$

When a sample containing compound with sulfur (designated also as RSH) at a sufficiently high concentration to cause precipitation of R<sub>S</sub>Ag is injected into the carrier stream, the silver ion concentration will be lowered to a new value. If  $c_{\text{RSH}} \cdot d \cdot m \gg c_{\text{Ag}^+} \cdot m$ , where dispersion of the sample is represented by the constant  $d$ , the free silver ion concentration at equilibrium can be analyzed and expressed as follows:

$$[\text{Ag}^+] = K_{\text{sp, R}_2\text{S}_2\text{Ag}} / [\text{RS}^-] \quad (15)$$

$$c_{\text{RSH}} = [\text{RS}^-] + [\text{RSH}] = [\text{RS}^-] + \frac{[\text{RS}^-] \cdot [\text{H}^+]}{K_{\text{a, RSH}}} \quad (16)$$

$$\alpha_{\text{RS}^-} = \frac{[\text{RS}^-]}{c_{\text{RSH}}} = \frac{[\text{RS}^-]}{[\text{RS}^-] + \frac{[\text{RS}^-] \cdot [\text{H}^+]}{K_{\text{a, RSH}}}} = \frac{K_{\text{a, RSH}}}{K_{\text{a, RSH}} + [\text{H}^+]} \quad (17)$$

$$[\text{RS}^-] = c_{\text{RSH}} \cdot \alpha_{\text{RS}^-} \quad (18)$$

$$[\text{Ag}^+] = K_{\text{sp, RSAg}} / \left( c_{\text{RSH}} \cdot \frac{K_{\text{a, RSH}}}{K_{\text{a, RSH}} + [\text{H}^+]} \right) \quad (19)$$

$$[\text{Ag}^+] = K_{\text{sp, RSAg}} \cdot \frac{K_{\text{a, RSH}} + [\text{H}^+]}{K_{\text{a, RSH}}} / c_{\text{RSH}} \cdot d \cdot m \quad (20)$$

where  $K_{\text{sp, RSAg}}$  is the solubility product of silver salt, while  $K_{\text{a, RSH}}$  is the dissociation constant of sulfhydryl group,  $K_{\text{a, RSH}} = [\text{RS}^-] \cdot [\text{H}^+] / [\text{RSH}]$ .

In the flow-injection measurements of compounds with highly reactive sulfhydryl group, the potential of the peak may be described by the following equation:

$$E_p = E'' + S \log \left\{ K_{\text{sp, RSAg}} \cdot \frac{K_{\text{a, RSH}} + [\text{H}^+]}{K_{\text{a, RSH}}} / c_{\text{RSH}} \cdot d \cdot m \right\} \quad (21)$$

The peak height  $h$  in these measurements is equal to the potential difference:

$$h = E_1 - E_p \quad (22)$$

and using equations (14) and (21), one can obtain an equation for peak height. Hence,  $f$ ,  $d$ ,  $m$ ,  $[\text{H}^+]$ , and  $c_{\text{Ag}^+}$  are kept constant, and  $c_{\text{RSH}} \cdot d \cdot m \gg c_{\text{Ag}^+} \cdot m$ , a linear dependence between the peak height and logarithm of concentration of RSH with the slope of  $59 \text{ mV} \{p(\text{RSH})\}^{-1}$ , can be obtained.

Application of a FIA system was exemplified by the determination of different compounds containing sulfur in  $0.1 \text{ mol L}^{-1} \text{ HClO}_4$  as a supporting electrolyte. For compounds with  $-\text{SH}$  group, a rectilinear calibration graph was obtained. The experimental slope was in good agreement with the theoretical value postulated on the precipitation process and formation of RSAg into the carrier stream or at the sensing part of the detector.

The equilibrium concentration of  $\text{Ag}^+$  ions will also be lowered if a sample contains RSH forms  $\text{Ag}(\text{SR})_i^{(1-i)}$  complexes instead of precipitation. Hence, if injected concentration of RSH is much higher than silver concentration in streaming solution, the potential of the peak may be described by the following equation:

$$E_p = E'' + S \log \left( c_{\text{Ag}^+} \cdot m \cdot \alpha_{\text{Ag}^+} \right) \quad (23)$$

$$\alpha_{\text{Ag}^+} = \frac{1}{1 + \beta_1 [\text{RS}^-] + \beta_2 [\text{RS}^-]^2 + \dots + \beta_i [\text{RS}^-]^i} \quad (24)$$

where  $\beta$  is the stability constant and  $[\text{RS}^-]$  is the free concentration of ligand. The concentration of ligand can be expressed by

$$[RS^-] = \left( c_{RSH} \cdot d \cdot m \cdot \frac{K_{a, RSH}}{K_{a, RSH} + [H^+]} \right) \quad (25)$$

If  $d$ ,  $m$ ,  $[H^+]$  and  $c_{Ag^+}$  are kept constant and  $c_{RSH} \cdot d \cdot m \gg c_{Ag^+} \cdot m$ , a linear dependence between the peak height and logarithm of  $c_{RSH}$  may be obtained, but only if in the denominator of equation (24) one term predominates and "1" can be neglected. The slope of the potentiometric response will be  $iS \text{ mV} \{p(RSH)\}^{-1}$ , where  $i$  is the number of ligands in the predominant complex. As it has been discussed [30], the solubility product of RSAg or the stability constant of  $Ag(SR)_i^{(1-i)}$  complex can be calculated when a continuous-flow instead of a flow-injection technique was applied.

Potentiometric determination of penicillamine (pen, RSH) was described based on a batch experiment and FIA method [32]. Also, the solubility product  $K_{sp, RSAg}$  was determined using experimental values recorded both by batch measurement and by the continuous-flow experiment. The mean value obtained by different measurements and using a membrane of the same composition (AgI+Ag<sub>2</sub>S+PTFE) was  $K_{sp, RSAg} = (1.4 \pm 0.1) \times 10^{-20}$ .

The preparation of a tubular electrode has been extended by means of chemical pretreatment of a silver tube with mercuric chloride and iodide solution. In this treatment AgI-sensing layer on the inner surface of tube was formed [33]. The electrode was used as a potentiometric sensor for the determination of ascorbic acid (vitamin C), glutathione and cysteine in batch and FIA experiments.

FIA system with cascade flow cell equipped with commercial FISE as detector has been described [34]. This system was applied for the determination of iron in the range of concentration from  $1.0 \times 10^{-4}$  to  $1.0 \times 10^{-1}$  mol L<sup>-1</sup>.

## 4.2. FIA-methods with spectrophotometric detector

Recently, more strict regulation related to the quality control in pharmaceuticals has led to an increase of demands on automation of the analytical assays carried out in appropriate control laboratories. The FIA became a versatile instrumental tool that contributed substantially to the development of automation in pharmaceutical analysis due to its simplicity, low cost and relatively short analysis time. A simple, rapid and sensitive flow-injection spectrophotometric method for the determination of NAC has been successfully developed and validated [35]. In this work TPTZ was proposed as a chromogenic reagent for the determination of NAC in aqueous laboratory samples, instead of frequently employed 1,10-phenantroline. Reaction mechanism of the method is based on the coupled redox-complexation reaction between NAC, Fe(III) and TPTZ. The use of TPTZ as chromogenic reagent has improved selectivity, linearity and sensitivity of measurements. The method was successfully applied for determination of NAC in pharmaceutical formulations. The flow-injection manifold for spectrophotometric determination of NAC is showed in Figure 5.

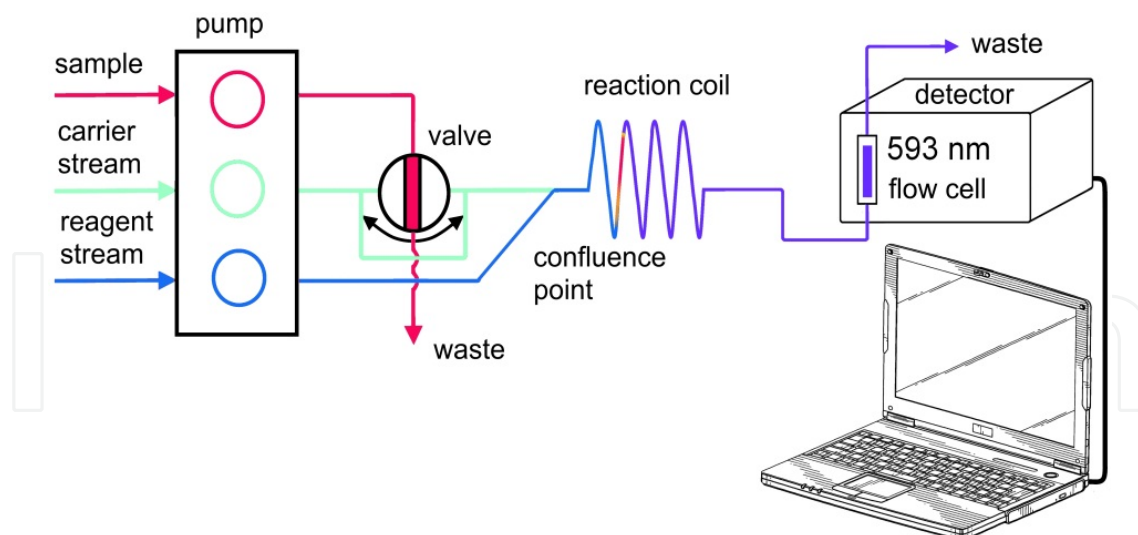

**Figure 5.** Flow-injection manifold configuration. Sample or standard solution (NAC); carrier stream (ultra pure water); reagent stream ( $1.0 \times 10^{-3} \text{ mol L}^{-1} \text{ Fe(III)}$  and  $1.0 \times 10^{-3} \text{ mol L}^{-1} \text{ TPTZ}$  in acetate buffer solution, pH 3.6); peristaltic pump (flow rate  $2.0 \text{ mL min}^{-1}$ ); injector valve (loop =  $500 \mu\text{L}$ ); confluence point (Y-type); reactor in coiled form (length: 300 cm, i.d. 0.8 mm); spectrophotometric detector ( $\lambda = 593 \text{ nm}$ ) equipped with flow cell (internal volume  $160 \mu\text{L}$ ).

In order to evaluate the potential of the proposed method for the analysis of real samples, flow-injection spectrometric procedure was applied to different pharmaceutical formulations (granules, syrup and dispersible tablets) for the determination of NAC. Recorded peaks refer to samples A, B and C are showed in the Figure 6.

A FIA spectrophotometric procedure for determination of *N*-(2-mercaptopropionyl)-glycine (MPG), tiopronin, has been proposed [36]. Determination was also based on the coupled redox-complexation reaction between MPG, Fe(III) and TPTZ. This coupled reaction was usefully used in development of the FIA method for determination of ascorbic acid in pharmaceutical preparations [37]. The proposed method is simple, inexpensive, does not involve any pre-treatment procedure and has a high sample analysis frequency.

## 5. Potential response of solid state potentiometric chemical sensors, theoretical approach and analytical teaching experiment

In this chapter a solid state potentiometric chemical sensors (PCS) used as detectors in the presented kinetic methods, performed in batch or flow-injection mode, are discussed. PCS make the use of the development of an electrical potential at the surface of a solid material when it is placed in a solution containing species which can be exchange (or reversibly react) with the surface. The species recognition process is achieved with a PCS through a chemical reaction at the sensor surface. Thus the sensor surface must contain a component which will react chemically and reversibly with the analyte in a contacting solution. The response of a solid state PCS to sensed ions in solution is governed by ion exchange or redox processes occurring between the electrode membrane and the solution. Since the transfer of the ions or electrons occurs across this membrane-solution interface, it is readily apparent that any

changes in the nature and composition of the membrane surface will affect these processes and hence the response of the sensor. The potential of PCS in kinetic experiments is formed due to heterogeneous reaction at the surface of membrane and homogeneous reaction in contacting solution. The potential response of solid state PCS with  $\text{Ag}_2\text{S} + \text{AgI}$  membrane has been extensively investigated in our laboratory. For better understanding the behavior of this sensor in kinetic experiments the following questions are discussed. i) Which chemical compound on the surface of the membrane is important for the response of the sensor? ii) Which heterogeneous chemical reaction (or reactions), occurring between the electrode membrane and the sensed ions in solution, forms the interfacial potential? iii) Which homogeneous chemical reaction (reactions) in solution is (are) important for the potential response of the sensor? Potentiometric measurements with PCS containing membrane prepared by pressing sparingly soluble inorganic salts can be used for teaching homogeneous and heterogeneous equilibrium. Learning objective is to distinguish between homogeneous and heterogeneous equilibrium, and between single-component and multi-component systems [38, 39].

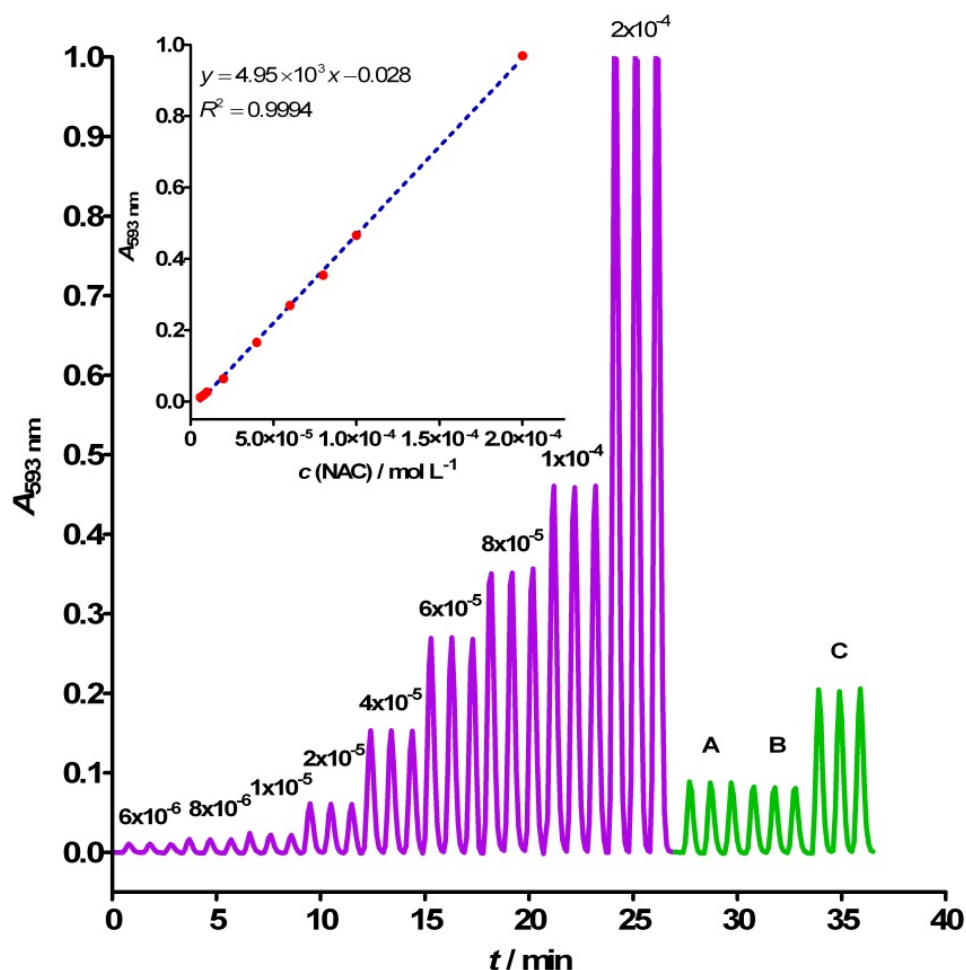

**Figure 6.** Diagram chart and calibration curve (inlet) for spectrophotometric determination of NAC over the concentration range from  $6.0 \times 10^{-6}$  to  $2.0 \times 10^{-4}$  mol L<sup>-1</sup>. Diagram includes recorded peaks for three samples: (A) Flumikan granules; (B) Flumikan Akut Junior syrup and (C) Flumikan Akut dispersible tablets



As it has been discussed, the determination of penicillamine was based on a batch and FIA experiments using PCS with AgI membrane. The membrane was prepared by pressing silver salts (AgI, Ag<sub>2</sub>S) and powdered Teflon (PTFE). This AgI-based membrane detector, sensitive to sulfhydryl group, can be applied to flow-injection determination of different compounds containing sulfur. In order to understand the effect of stirring or flowing to potential response of sensor, for both kind of kinetic experiment (batch and FIA), it is necessary to develop a picture of liquid flow patterns near the surface of sensor in a stirred or flowing solution.

According to Skoog [40] three types of flow can be identified. *Turbulent flow* occurs in the bulk of the solution away from the electrode and can be considered only in stirred solution during batch kinetic experiment. Near the surface of electrode *laminar flow* take place. In FIA experiment only laminar flow exists in the tube. For both kind of kinetic experiments (batch and FIA) at 0.01 - 0.50 mm from the surface of electrode, the rate of laminar flow approaches zero and gives a very thin layer of stagnant solution, which is called the *Nernst diffusion layer* (Ndl). According Equation (13), the potential of sensor is determined by activity of Ag<sup>+</sup> ion in Ndl.

When the membrane of the sensor, containing both Ag<sub>2</sub>S and AgI, is immersed in a solution with Ag<sup>+</sup> or I<sup>-</sup> ions heterogeneous equilibrium at the phase boundary is established. The potential difference between the solution phase and the solid phase of the sensor is built up by a charge separation mechanism in which silver ions distribute across the membrane/solution interface as shown in Figure 7.

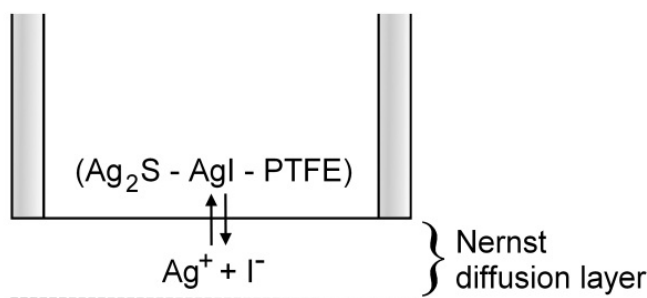

**Figure 7.** Heterogeneous equilibrium at the phase boundary between AgI-based membrane and solution.

The stable potential of PCS with AgI + Ag<sub>2</sub>S membrane in contact with penicillamine (RSH) solution can be explained by the following consideration. According to the picture of liquid flow near the surface of sensor in a stirred or a flowing solution (Fig. 7) the potential of the sensor is determined by activity of Ag<sup>+</sup> ion in Ndl. In FIA experiment PCS with AgI + Ag<sub>2</sub>S membrane (before injection of penicillamine) was in contact with flowing solution of Ag<sup>+</sup> ion, and the concentration of Ag<sup>+</sup> ions in solution including Ndl was 6.30×10<sup>-6</sup> mol L<sup>-1</sup>. The formation a new solid state phase in Ndl or/and at the surface of the sensing part of the tubular flow-through electrode unit may be expressed by the next reaction:



with appropriate equilibrium constant.

$$K_{\text{eq}} = \frac{[\text{H}^+]}{[\text{Ag}^+] \cdot [\text{RSH}]} \quad (27)$$

$$K_{\text{eq}} = \frac{K_a}{K_{\text{sp, RSAg}}} \quad (28)$$

By using the experimentally established constant of solubility product [32]  $K_{\text{sp, RSAg}}$ , the dissociation constant of penicillamine, [41]  $K_a$ , and Equation (28) the equilibrium constant can be calculated.

$$K_{\text{eq}} = \frac{3.16 \times 10^{-11}}{1.40 \times 10^{-20}} = 2.26 \times 10^9$$

The calculated value of equilibrium constant suggests completeness of the new phase formation reaction at the surface of membrane. In addition, it can be supposed that, by adsorption process, both parts of membrane, AgI and Ag<sub>2</sub>S, are covered with a thin layer of RSAg precipitate (Fig. 8). Under these conditions, the equilibrium activity of Ag<sup>+</sup> ions and the corresponding response of PCS are governed by new heterogeneous equilibrium.

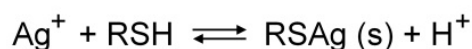
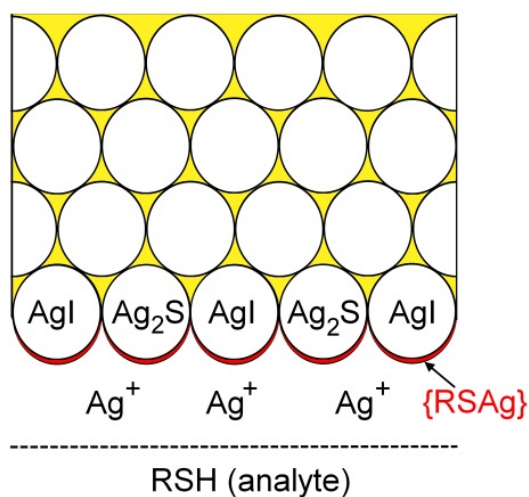

**Figure 8.** New phase formation in Ndl and its adsorption on the surface of membrane.

Now we can calculate the minimal concentration of penicillamine, or any other RSH compound, which cause precipitation of RSAg in acid media.

$$K_{\text{eq}} = \frac{[\text{H}^+]}{[\text{Ag}^+] \cdot c(\text{RSH}) \cdot \alpha(\text{RSH})} = 2.26 \times 10^9 \quad (29)$$

$$c(\text{RSH}) \geq \frac{[\text{H}^+]}{[\text{Ag}^+] \cdot K_{\text{eq}} \cdot \alpha(\text{RSH})} \quad (30)$$

$$\alpha(\text{RSH}) = \frac{[\text{RSH}]}{c(\text{RSH})} = \frac{[\text{RSH}]}{[\text{RS}^-] + [\text{RSH}]} \quad (31)$$

If we express  $[\text{RS}^-]$  with dissociation constant of RSH,

$$[\text{RS}^-] = \frac{K_{\text{a,RSH}} \cdot [\text{RSH}]}{[\text{H}^+]}$$

we obtain

$$\alpha(\text{RSH}) = \frac{[\text{H}^+]}{K_{\text{a,RSH}} + [\text{H}^+]} \quad (32)$$

In 0.100 mol L<sup>-1</sup> perchloric acid, where experiment was performed,  $\alpha(\text{RSH}) \approx 1$ .

$$c(\text{RSH}) \geq \frac{0.100}{6.3 \times 10^{-6} \cdot 2.29 \times 10^9 \cdot 1}$$

$$c(\text{RSH}) \geq 7.0 \times 10^{-6} \text{ mol L}^{-1}$$

This concentration of penicillamine may be estimated as the detection limit for describing experimental conditions. The solution of Ag<sup>+</sup> was pumped as a reagent in a two-line flow manifold typically at a concentration of 10<sup>-5</sup> mol L<sup>-1</sup> with 0.1 mol L<sup>-1</sup> perchloric acid as a pH and ionic-strength adjuster.

### List of abbreviations

AA	L-ascorbic acid
cys	L-cysteine
DA	dehydrogenized (oxidised) form of ascorbic acid
EDTA	ethylenediaminetetraacetic acid
FIA	flow injection analysis
FISE	fluoride ion-selective electrode

glu	L-glutathione
H <sub>2</sub> A	reduced form of ascorbic acid
LOV	lab-on-valve
MPG	<i>N</i> -(2-mercaptopropionyl)-glycine
NAC	<i>N</i> -acetyl-L-cysteine
Ndl	Nernst diffusion layer
PCS	potentiometric chemical sensor
pen	D-penicillamine
phen	1,10-phenantroline
PTFE	polytetrafluoroethylene, Teflon
RSH	thiol compound
SIA	sequential injection analysis
TPTZ	2,4,6-tripyridyl-s-triazine

## Author details

Njegomir Radić and Lea Kukoc-Modun

*Department of Analytical Chemistry, Faculty of Chemistry and Technology, University of Split, Croatia*

## 6. References

- [1] Mottola HA. Kinetic aspects of analytical chemistry. New York: John Wiley & Sons 1988.
- [2] Mark HB, Rechnitz GA. Kinetics in analytical chemistry. New York: John Wiley & Sons 1968.
- [3] Cattrall RW. Chemical Sensors. Oxford: Oxford University Press 1997.
- [4] Brand MJD, Rechnitz GA. Surface films on glass membrane electrodes [1]. Analytical Chemistry. 1970;42(2):304-305.
- [5] Srinivasan K, Rechnitz GA. Reaction rate measurements with fluoride ion-selective membrane electrode: Formation kinetics of ferrous fluoride and aluminum fluoride complexes. Analytical Chemistry. 1968;40(12):1818-1825.
- [6] Radić N, Komljenović J. Kinetic potentiometric determination of Fe(III) using a fluoride ion-selective electrode. Croatica Chemica Acta. 1991;64:679-687.
- [7] Radić N. Determination of nanomole amounts of aluminium by use of a fluoride ion-selective electrode. The Analyst. 1976;101:657-660.
- [8] Trojanowicz M, Hulanicki A. Microdetermination of aluminium with fluoride-selective electrode. Mikrochimica Acta. 1981;76(1-2):17-28.
- [9] Radić N, Bralić M. Kinetic - potentiometric determination of aluminium in acidic solution using a fluoride ion-selective electrode. Analyst. 1990;115(6):737-739.
- [10] Plankey BJ, Patterson HH, Cronan CS. Kinetics of aluminum fluoride complexation in acidic waters. Environmental Science and Technology. 1986;20(2):160-165.

- [11] Radić N, Bralić M. Aluminium fluoride complexation and its ecological importance in the aquatic environment. *Science of the Total Environment*. 1995;172(2-3):237-243.
- [12] Radić N, Vudrag M. Kinetic determination of iron(III) with a copper(II) selective electrode based on a metal displacement reaction. *Journal of Electroanalytical Chemistry and Interfacial Electrochemistry*. 1984;178(2):321-327.
- [13] Martinović A, Radić N. Kinetic potentiometric determination of some thiols with iodide ion-sensitive electrode. *Analytical Letters*. 2007;40(15):2851-2859.
- [14] Baumann EW, Wallace RM. Cupric-selective electrode with copper(II)-EDTA for end point detection in chelometric titrations of metal ions. *Analytical Chemistry*. 1969;41(14):2072-2073.
- [15] Van Der Meer JM, Den Boef G, Van Der Linden WE. Solid-state ion-selective electrodes as end-point detectors in ompleximetric titrations. Part I. The titration of mixtures of two metals. *Analytica Chimica Acta*. 1975;76(2):261-268.
- [16] Radić N. Metal ( $\text{Fe}^{3+}$ ,  $\text{Cu}^{2+}$ ) - EDTA complex formation studies in ethanol-aqueous mixtures with cupric ion-selective electrode. *Analytical Letters*. 1979;12:115 – 123.
- [17] Radić N, Milišić M. Sulfide ion-selective electrode as potentiometric sensor for lead(II) ion in aqueous and nonaqueous medium. *Analytical Letters*. 1980;13:1013 – 1030.
- [18] Midgley D, Torrance K. *Potentiometric water analysis*. 2 ed. New York: John Wiley & Sons 1991.
- [19] Radić N, Prugo D, Bralić M. Potentiometric titration of aluminium with fluoride in organic solvent + water mixtures by use of a fluoride-selective electrode. *Journal of Electroanalytical Chemistry*. 1988;248(1):87-98.
- [20] Radić N, Papa M. Electroanalytical Study of Aluminum Fluoride Complexation in 2-Propanol-Water Mixtures. *Analytical Sciences*. 1995;11:425-429.
- [21] Martinović A, Kukoč-Modun L, Radić N. Kinetic spectrophotometric determination of thiols and ascorbic acid. *Analytical Letters*. 2007;40(4):805-815.
- [22] Taha EA, Hassan NY, Abdel Aal F, Abdel Fattah LES. Kinetic spectrophotometric determination of acetylcysteine and carbocysteine in bulk powder and in drug formulations. *ScienceAsia*. 2008;34(1):107-113.
- [23] Kukoc-Modun L, Radic N. Kinetic Spectrophotometric Determination of *N*-acetyl-L-cysteine Based on a Coupled Redox-Complexation Reaction. *Analytical Sciences*. 2010;26(4):491-495.
- [24] Kukoc-Modun L, Radić N. Novel kinetic spectrophotometric method for determination of tiopronin [N-(2-mercaptopropionyl)-glycine]. *Croatica Chemica Acta*. 2010;83(2):189-195.
- [25] Teshima N, Katsumata H, Kurihara M, Sakai T, Kawashima T. Flow-injection determination of copper(II) based on its catalysis on the redox reaction of cysteine with iron(III) in the presence of 1,10-phenanthroline. *Talanta*. 1999;50(1):41-47.
- [26] Ruzicka J, Hansen EH. *Flow injection analyses*. Part I. A new concept of fast continuous flow analysis. *Analytica Chimica Acta*. 1975;78(1):145-157.

- [27] Hansen EH, Miro M. How flow-injection analysis (FIA) over the past 25 years has changed our way of performing chemical analyses. *TrAC - Trends in Analytical Chemistry*. 2007;26(1):18-26.
- [28] Van Staden JF. Flow injection determination of inorganic bromide in soils with a coated tubular solid-state bromide-selective electrode. *The Analyst*. 1987;112(5):595-599, Toth K, Lindner E, Pungor E, Kolev SD. Flow-injection approach for the determination of the dynamic response characteristics of ion-selective electrodes. Part 2. Application to tubular solid-state iodide electrode. *Analytica Chimica Acta*. 1990;234(1):57-65.
- [29] Komljenović J, Radić N. Design and properties of flow-through electrode with AgI-based membrane hydrophobized by PTFE; application to flow-injection determination of thiourea. *Sensors and Actuators: B Chemical*. 1995;24(1-3):312-316.
- [30] Radić N, Komljenović J. Flow-injection determination of compounds containing sulfur by using potentiometric tubular sensor. *Laboratory Robotics and Automation*. 1998;10(3):143-149.
- [31] Komljenović J, Radić N. Use of a multi-purpose solid-state ion-selective electrode body and an AgI-based membrane hydrophobised by PTFE for the determination of  $I^-$  and  $Hg^{2+}$ . *The Analyst*. 1986;111(8):887-889.
- [32] Radić N, Komljenović J, Dobčnik D. Determination of penicillamine by batch and flow-injection potentiometry with AgI-based sensor. *Croatica Chemica Acta*. 2000;73(1):263-277.
- [33] Kolar M, Dobčnik D, Radić N. Potentiometric flow-injection determination of vitamin C and glutathione with a chemically prepared tubular silver electrode. *Pharmazie*. 2000;55(12):913-916, Kolar M, Dobčnik D, Radić N. Chemically treated silver electrodes for the determination of cysteine. *Mikrochimica Acta*. 2002;138(1-2):23-27.
- [34] Bralić M, Radić N. Flow injection potentiometric determination of Fe(III) using a fluoride-selective electrode as detector. *Analisis*. 1999;27(1):57-60.
- [35] Kukoc-Modun L, Plazibat I, Radić N. Flow-injection spectrophotometric determination of *N*-acetyl-L-cysteine based on coupled redox-complexation reaction. *Croatica Chemica Acta*. 2011;84(1):81-86.
- [36] Kukoc-Modun L, Radić N. Flow-injection spectrophotometric determination of tiopronin based on coupled redox-complexation reaction. *Chemia Analytyczna*. 2009;54(5):871-882.
- [37] Kukoc-Modun L, Biocic M, Radić N. Indirect method for spectrophotometric determination of ascorbic acid in pharmaceutical preparations with 2,4,6-tripyridyl-s-triazine by flow-injection analysis. *Talanta*. 2012;96:174-179.
- [38] Radić N, Komljenović J. Potential response of solid state potentiometric chemical sensors, theoretical approach and teaching experiment. *Acta Chimica Slovenica*. 2005;52(4):450-454.
- [39] Radić NJ, Dobčnik D. Surface compounds and reactions in relation to the response of solid state potentiometric chemical sensors. *Surface Review and Letters*. 2001;8(3-4):361-365.

[40] Skoog DA, West DM, Holler EJ, Crouch SR. Fundamentals of Analytical Chemistry. 8 ed. Belmont: Thomson 2004.

[41] The Merck Index, Merck Research Laboratories, New York, 1996.

IntechOpen

IntechOpen